

Materials and Processes for MR and GMR Heads and Assemblies

Dr. K. Gilleo, Cookson Electronics (now ET-Trends; gilleo@ieee.org)

N. Kerrick and G. Nicholls, AMPM

Introduction

Magnetic storage technology continues to produce phenomenal advancements in density and speed with cost reduction displaying a trend line that will continue far into the next millenium. The hard disk drive (HDD) is the epitome of faster-smaller-cheaper and a tribute to technologists, designers and manufacturers. HDDs are a masterpiece of physics, mechanics, materials, electronics and, very soon, optics.

Solid state devices have supported or perhaps heeded Moore's Law for decades and ICs (integrated circuits) continue to demonstrate a doubling of density about every 18 months. But magnetic storage follows its own rendition of Moore's Law and in many ways parallels the IC industry to which it is so closely linked. Incredibly, memory has been delivering an astounding 60% increase in areal density every year and actually surpasses the IC industry. Both IC and magnetic disk technology gain density and speed increase by physical size reduction. Smaller transistors with shorter connection paths enable faster clock rates and more devices per chip. Smaller read/write heads, smaller disks and tinier magnetic domains allow more storage per unit area, faster access rates and reduced manufacturing costs. Each technology has managed to sustain this relentless quest for performance increase by periodic breakthroughs. ICs are beginning to reap the benefits of the transition to copper conductors. Magnetic storage is now harvesting the rewards of MR (Magnetoresitive) with GMR (Giant Magnetoresistive) technology just starting to capture share. Let's now look at the GMR and MR effects and the adaptation into high density HDD.

MAGnificent Records

In some ways, the magnetic storage field is even more impressive than the IC arena since so many technical sectors are required, not just electronics. Areal density records are broken so often, that we must look for press releases on the Internet to know where the record stands.

The hard disk drive industry was launched way back in 1955, but it was the personal computer (PC) that provided the stimulus to boost density while reducing cost through clever designs and high volume manufacturing efficiencies. Many will recall when the IBM XT, with its 10 MB hard drive, was state-of-the-art. But there was also a time when power users had to add a second HDD to break the memory bottleneck. And then memory densities exploded. We still have not reached the "brick wall" known as the supermagnetic limit where magnetic domains can not be further reduced, however. This means that we could see densities continue to double for awhile until another

breakthrough is required and this will come when optics and magnetics are combined in a cost-effective manner.

Today, laptops boast many gigabytes of quick-access highly dependable magnetic storage. The density records from both IBM and ReadRite, appearing on web sites in Q2 1999, were over 20 million bits per square inch. This translates to 2.5 GB (Gigabyte) per a square inch of disk space and that single inch is enough to hold 2,500 books. What's really incredible is that this lab-demonstrated density is considerably higher than CD-ROM, once thought to be the "terminator" for magnetic media. Just the area in a 0.25" x 0.25" section of such a disk, smaller than a memory chip, can hold the equivalent of a CD ROM disk. While memory has increased by 50 times, it has dropped 300 times in cost in just 8 short years according to IBM [1]. A 145-MB drive cost over \$5,000/GB in 1991, but the price had dropped to less than \$18.5/GB in 1999. Magnetic storage cost could drop to \$0.02/megabyte in year 2000 according to DISK/TREND Inc.

MR vs. GMR

The MR Effect was actually discovered way back in 1857 by British scientist Lord Kelvin. Magnetoresistive material is typically a nickel-iron alloy that shows higher electrical resistance when the current flow is parallel to the magnetic orientation. The resistance drops back to the initial value when the magnetic field is removed. Even the small magnetic domains on very dense disk drives will trigger the magnetoresistive effect sufficiently to permit the reading of stored bits. We can take advantage of the MR effect by making very thin sensor layers of MR film. The magnetic field orientation of the MR strip is parallel to the disk when no transverse magnetic field is applied and the electrical resistance is higher. A magnetic field rotates the sensor's magnetic orientation to reduce electrical resistance that can be detected.

The GMR effect, discovered by IBM in 1988 [2], is not just a scaled version of MR. Giant Magnetoresistive phenomenon is actually a quantum effect. The GMR sensors utilize the quantum nature of electrons that have two spin states, up and down. Conducting electrons with spin direction parallel to the sensor film's magnetic orientation move easily and thus produce low electrical resistance. But the movement of electrons of opposite spin direction is impeded by frequent collisions with atoms in the film thereby producing higher resistance. The so-called "spin valve" head structure incorporates a design where one magnetic film is pinned (magnetic orientation is fixed) and the second sensor film has a variable (free) orientation. These films are placed close together so that electrons of either spin direction can move back and forth. Changes in the external magnetic field orientation provided by the rotating disk cause magnetic rotation of the sensor film's orientation. This changing magnetic orientation alters the electrical resistance of the sensor array. Low resistance occurs when the sensor and pinned films are magnetically orientated in the same direction because

electrons with parallel spin direction move freely in both films. Higher resistance occurs when magnetic orientations of the pinned and sensor films are opposite because the electron movement of either spin direction is hampered by one or the other films.

GMR sensitivity is twice as high as MR and is now used for the highest performance disks. Magnetically-sensitive resistors, called spin valves, are built into very small read heads that must be in very close proximity to the rotating disk. Electrical current running through the GMR element fluctuates instantaneously with the polarity of the magnetic field. The resulting voltage changes become the signal that is first amplified and then decoded. The accompanying noise is digitally filtered out. Figure 1 shows the construction. The two shields help narrow the pulses allowing smaller bits to be read. The GMR element is extremely thin, now only 15 atom layers, and the dimensions will become even smaller in the future. Figure 1 also compares MR and GMR structures.

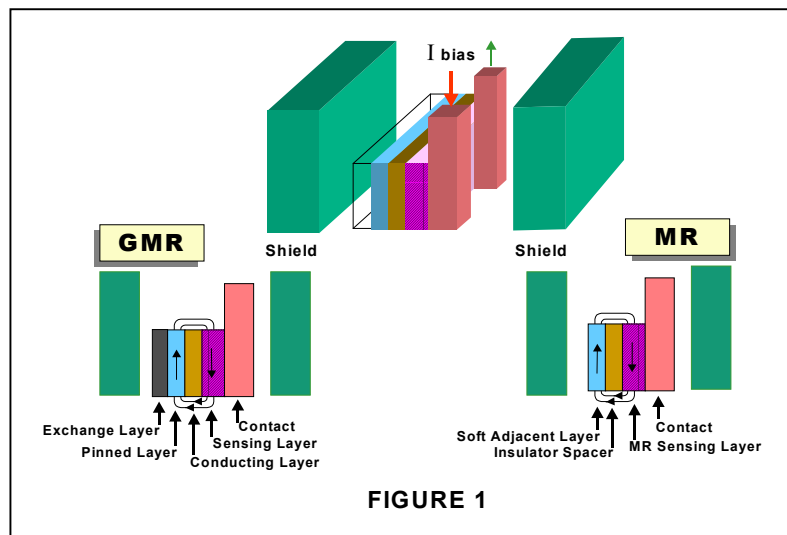

Head Construction

Writing

Modern magnetic heads combine elements of the read and write functions into a single, or a “merged head” using the IBM terminology. This offers better manufacturing economics and also greater density. Writing employs a magnetic coil that is activated each time a bit is written, or magnetized on the spinning disk. A simplified writing head is shown in Figure 2. The small, concentrated magnetic field magnetizes, or “turns on”, a region on the disk by induction. The gap at the bottom concentrates the field over the disk. When current is applied to generate the magnetic field, the “hard” disk medium is permanently magnetized with a polarity that matches the writing field. Reversing the current reverses the polarity on the disk bit to rewrite or erase the information stored in digital format.

The write head may be less than 30 microns above the rapidly spinning disk and the transaction is virtually instantaneous. In the future, higher density may require a near-zero gap. Figure 3 shows the process of writing on magnetic disk medium.

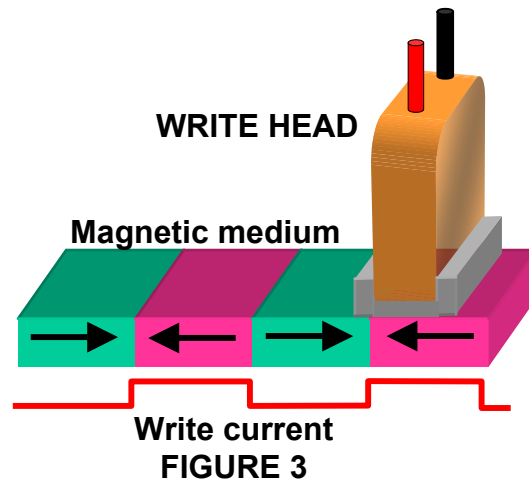
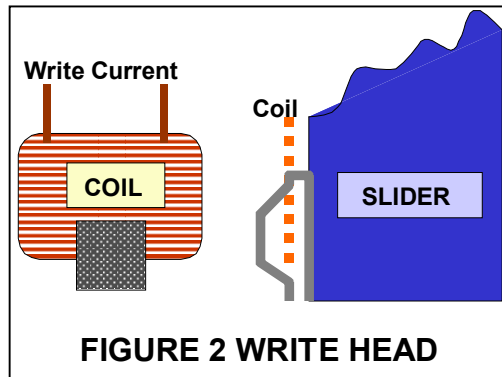

A timing clock is synchronized with disk rotation so that the location of the head with the magnetic “bit cells” is precisely known and controlled. Bits represent ones and zeros (reversed magnetic polarity). Although the disk is permanently magnetized, bits are easily reversed, or rewritten, as the head applies an opposite magnetic field produced by simply reversing the coil current. MR and GMR require more precise synchronization since the domains are smaller.

Reading

The task of the READ portion of the head is to read the disk data bits. Reading is where the state-of-the-art technology is being applied and where MR and the newest GMR principles are being applied. Both MR and GMR use a somewhat similar head structure. The very thin MR or GMR sensor strips are sandwiched between oppositely biased contact elements and this component is placed between two magnetic shields to reduce stray magnetic fields. MR and GMR head structures are shown in Figures 3 and 4. The Soft Adjacent Layer (SAL) is magnetized by the nearby field. The SAL produces a magnetic field that biases the magnetization in the MR element so that its magnetic field angle is shifted to 45° , the optimum angle for this type of sensor.

Merged Heads

Although reading and writing are independent functions, it is critical to place the write and read heads close together and near the recording medium. Writing heads are therefore fabricated directly onto the spin valve GMR reading heads. The top shield of the GMR sensor becomes the bottom magnetic pole of the writing head as shown in Figure 4 to form an integrated or merged head design. The GMR head and writing head share one magnetic layer. The efficient integrated READ-WRITE assembly is referred to as a merged head.

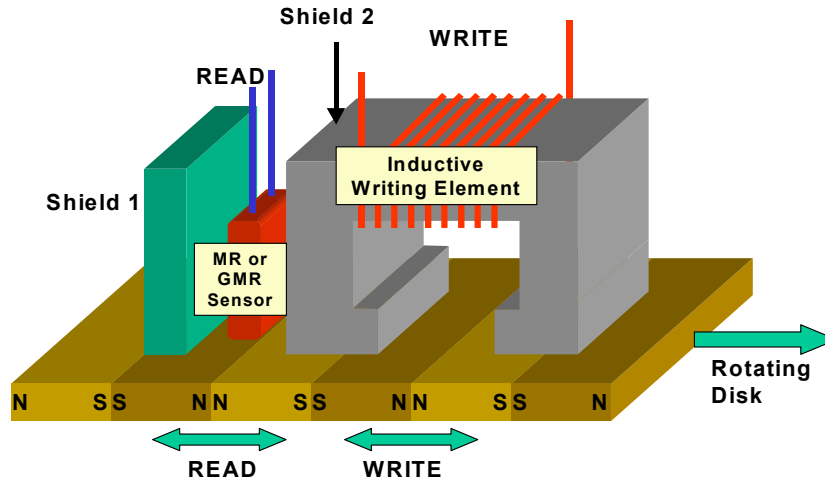

MERGED READ-WRITE HEAD
Figure 4

Manufacturing MR and GMR Head Elements

Head elements are produced using several semiconductor processes that include photolithography, vacuum deposition and ion beam etching. Multiple layers of metals and alloys are vacuum-deposited to achieve high sensitivity to magnetic perturbations. Once the complex wafer structure has been crafted, it must be carefully sawn with a dicing blade. Multi-blade saws are now being used for higher productivity where five or more cuts can be made concurrently. The first step is to thin and polish the wafer by lapping. The lapped wafer is next sliced into rows that are further processed. The very first step, however, is to bond entire wafer to a base platform material like lava stone or graphite. Graphite is becoming popular because it helps with ESD (electrostatic discharge) when the grounded blade comes in contact with this partially conductive material. The use of a sacrificial base facilitates clean, complete slicing into rows as shown in Figure 5 that also describes the process steps.

Temporary Adhesives

Bonding the wafer to the base requires special adhesives that are tailored to the type of wafer and process. Different adhesive systems may be used for MR and GMR. The adhesive must form a strong, reliable bond for the mechanical and chemical processing. Later, the adhesive must release the sawed parts by a process known as debonding. The adhesive layer may require some level of electrical conductivity for ESD control a feature of increasing importance as head materials become more exotic. Both pure and filled thermoplastics have been found to function well for this type of application. Conductive fillers can further assist with ESD control but the fillers cannot cause contamination.

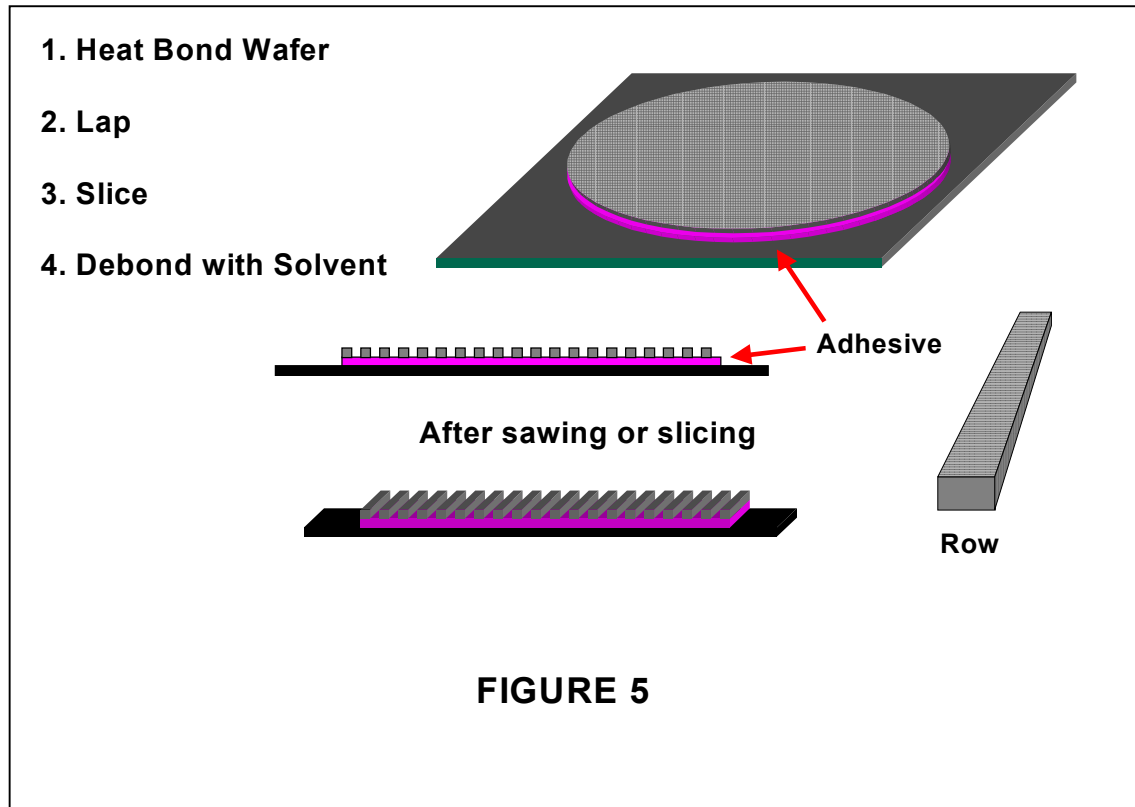

Thermoplastics, unlike the more common thermosets, will soften at higher temperatures to allow efficient bonding and debonding. The thermosets will also swell and lose adhesion in specific polar solvents without dissolving. Solvent debonding can therefore be a clean, low stress method of detaching and is preferred by most magnetic head processors over thermal methods. The swelled adhesive simply loses bonding properties without dissolving. Debonding by solvent swelling is favored since no contamination results. The steps are indicated in Figure 5 that shows the wafer-to-carrier lay-up and resulting rows after lapping and slicing.

Thermoplastic temporary adhesives have attributes that make them well suited for magnetic head processing. The adhesive materials can be cast onto release liners as liquid polymer solutions and dried into films of a specific thickness. The precision thickness films produce a consistent and uniform adhesion with a uniform bond line for low stress and planar processing so important to magnetic head manufacturing. A uniform bond line is especially important during any lapping process so that consistent thinning results. The thermoplastics also can have lower modulus than thermosets and this produces low stress and more uniform rows with low bowing. While these adhesives are temporary, they generate very high adhesion forces that are essential for slicing the very small and fragile parts. In fact, as testimony to their high performance, it should be mentioned that thermoplastics have been used for many years as reworkable die attach adhesives and are renowned for strength and reliability. Thermoplastics

debond on “command” by adding special solvents such as acetone or NMP (N-methyl pyrrolidone). Thermoplastics are also available that debond with very mild IPA (isopropyl alcohol) solvent.

Row/Slider Processing

The individual rows, once debonded, are now attached to a fixture using thermoplastic adhesive. Thermoplastic paste, made up of polymer resin dissolved in suitable solvent, is dispensed onto a multiple location fixture as shown in Figure 6. Figure 7 shows further head details. The sliced head rows are placed into the adhesive paste and heat is applied to evaporate the paste solvent and “fix” the rows. The rows are processed in various ways, including lapping and ion milling. They may be debonded, rotated on the row axis and re-bonded to permit processing on other sides.

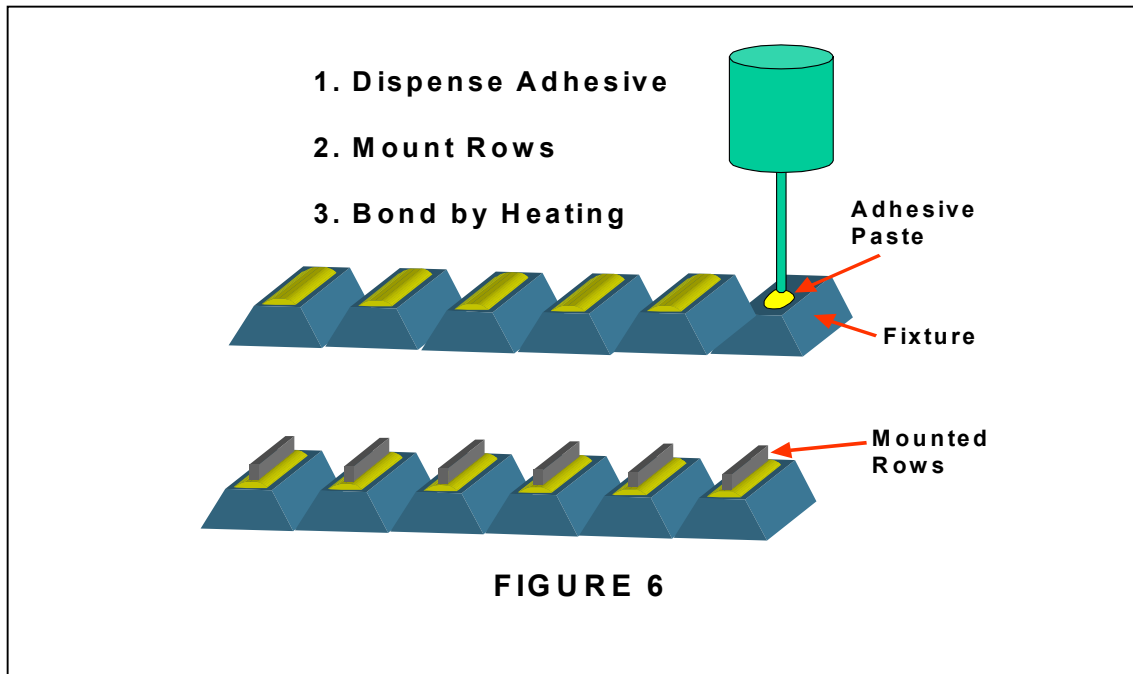
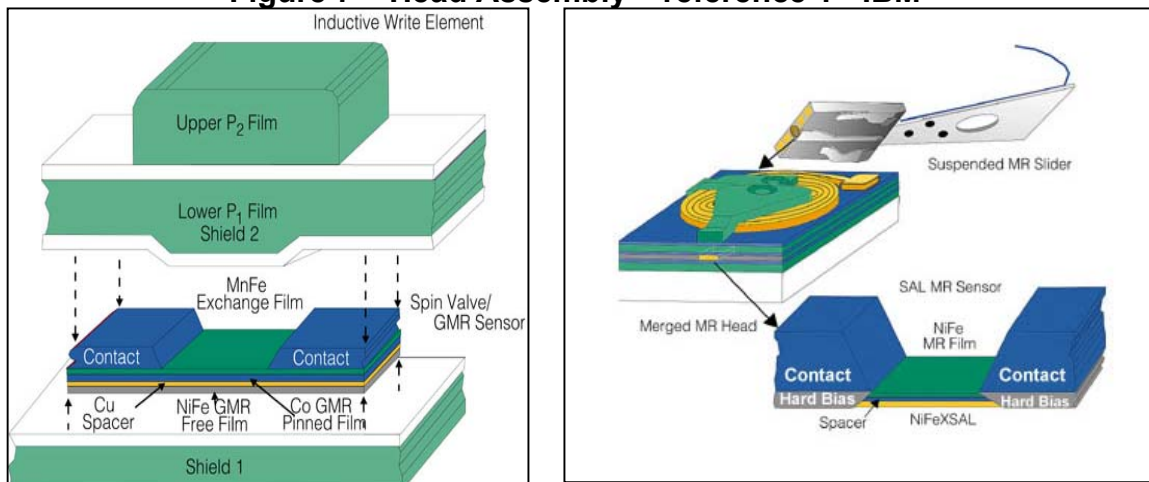

Figure 7 – Head Assembly – reference 1 - IBM



Head components are eventually singulated while still held tightly to the fixture. The last step is debonding with solvent. Although unfilled adhesives have been used, new electrically conductive pastes are being evaluated for ESD control since the heads are very static-sensitive at this stage. The MR/GMR heads are now ready to be fabricated into read-write assemblies that are attached to the slider and connected to the positioner. A dynamic flexible circuit provides the signal interconnection between the head assembly and other electronics. The flex circuit typically contains the preamplifier as shown in Figure 8.

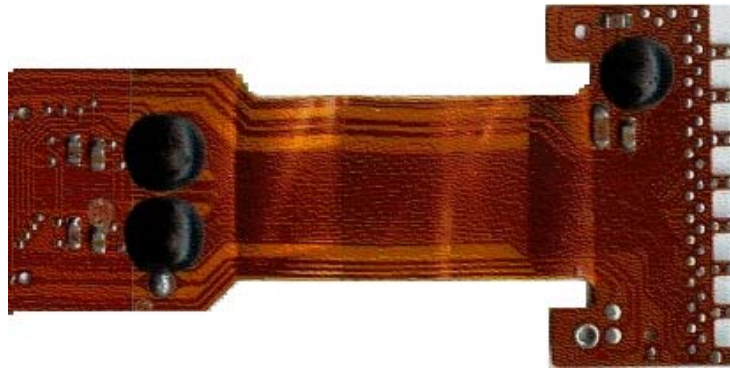

Figure 8 – Flex HDD Circuit with COB

Assembling the Amplifier

The sensitive MR and GMR head assemblies require amplification and signal conditioning. The best improvement in signal to noise is obtained when the head and amplifier are close together. This can only be achieved by having the amplifier on the dynamic flex circuit that connects to the head. The earliest on-flex designs used tiny surface mount devices. The next improvement was achieved by using Chip-on-Board (COB) assembly where the bare die amplifier was bonded to the flex and interconnected by wire bonding as shown in Figure 8. Encapsulation or “glob top” provides protection for the bare die.

The latest approach uses Direct Chip Attach (DCA) better known as Flip Chip (FC). Bare die are bumped with conductors such as solder to allow the IC to be “flipped” face down and solder to pads on the circuit. When bumps are made with eutectic solder, the chip can be placed on the flex, with the appropriate flux, and run in a reflow oven to join the FC to the circuit. FC gives the shortest signal path, lowest profile and weight. Major players, like IBM and Seagate, are using Flip Chip, but all HDDs will convert to this highest performance format in the future.

There is one final step known as underfilling. This involves flowing a solventless polymer system under the die followed by polymerization. The underfill seals the interconnect structure and also bonds the chip and substrate tightly together (mechanically coupled) to counter thermally induced differential expansion that would eventually cause the solder joints to fatigue and fail. The problem arises because the FC has very low thermal expansion while the circuit substrate has a

relatively high coefficient of thermal expansion (CTE) that produces thermomechanical stress every time the temperature changes. The underfill locks the high modulus chip to the low modulus organic circuit material to restrain circuit movement and eliminate solder joint strain. The underfilled FC can survive more than 1000 thermal cycles (-55°C to 125°C) and has been shown to be very reliable in disk drive use. Figure 9 shows a dynamic flex disk drive assembly with a flip chip assembled and underfilled.

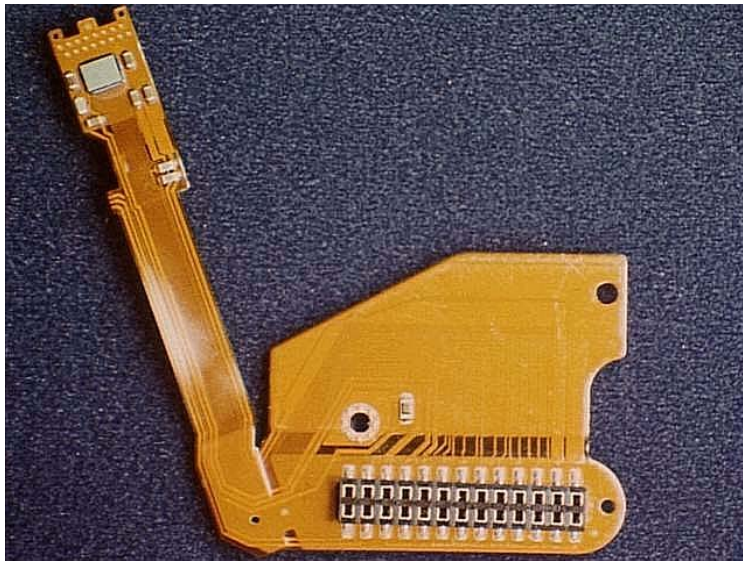

Figure 9 – Disk Drive Flex with Flip Chip

Tens of thousand of FCs are assembled each day on disk drive circuits and the number is rapidly growing as essentially all products switch to this more efficient technology. One slow step in the process is underfilling where liquid is dispensed along the edge of the assembled chip and allowed to flow completely underneath. The underfill must then be cured by exposure to heat from 5 minutes up to ½ hour. Efforts are underway to modify the underfill step and combine it with solder assembly. Newer underfills with fluxing properties can be applied to the FC bond site before assembly. The chip is then placed and the assembly is run through reflow. The “pre-applied” underfill first serves as a flux and then polymerizes to a strong hard underfill. The dispensing step is simplified and the underfill baking step is eliminated. Figure 10 shows one-step solder/underfill processes.

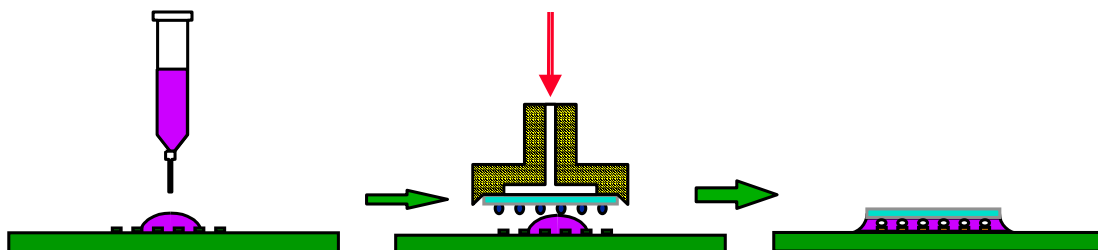

Figure 10 – Pre-Applied Flux/Underfill Process

The ultimate flex/underfill lies just a little further down our technology highway - wafer-level materials. Here, flux/underfill liquid will be applied at wafer level and hardened. The ready-to-bond flip chip will simply be placed onto the circuit and run through a reflow oven. The material will melt, flux the site and then polymerize to underfill. The advent of W-L processed flip chips is expected to boost this technology significantly due to high productivity gains and the ability to run FCs on ordinary SMT lines. Our code name for this program is FC=SMT™.

Summary

The HDD has had an amazing record of progress even surpassing that of the semiconductor industry. Many breakthroughs have occurred and more are likely. Adhesive materials have played a key role in this progress. Temporary attach adhesives make MR and GMR head processing feasible and practical. Underfills enable ultimate performance flip chip assembly. In the future, new materials will be ready to help HDD achieve new goals in the never-ending quest for more performance at an affordable cost.

References

1. IBM web site; <http://www.storage.ibm.com>
2. Grunberg, P. "Magnetic Field Sensor With Ferromagnetic Thin Layers Having Magnetically Antiparallel Polarized Components", U.S. Patent 4,949,039, June 14, 1989.